



Earth 2/3
MI 2126
Instruction Manual
Version 1.0, Code No. 20 750 190

Distributor:

Manufacturer:

METREL d.d.
Ljubljanska cesta 77
1354 Horjul
Slovenia

web site: <http://www.metrel.si>
e-mail: metrel@metrel.si



Mark on your equipment certifies that this equipment meets the requirements of the EU (European Union) concerning safety and interference causing equipment regulations

© 2005 METREL

No part of this publication may be reproduced or utilized in any form or by any means without permission in writing from METREL.

1	Introduction	4
1.1	General description.....	4
1.2	Warnings.....	4
1.3	Standards applied.....	5
2	Instrument description	6
2.1	Instrument casing	6
2.2	Front panel.....	6
2.3	Connector panel	7
2.4	Base	7
2.5	Instrument messages	8
3	Using instrument	9
3.1	Performing 3-wire measurement.....	9
3.2	Performing 2-wire measurement.....	11
3.3	General settings.....	14
4	Maintenance	16
4.1	Batteries.....	16
4.2	Replacing fuse	17
4.3	Cleaning.....	17
4.4	Periodic calibration	17
4.5	Service.....	17
5	Technical specification	18
5.1	Functions	18
5.2	General characteristics	19
6	Standard and optional accessories	20

1 Introduction

We are very pleased to offer a high quality, professional grade test instrument, for performing two- and three-wire earth resistance measurements, on which the estimation of earthing quality is based. The equipment was designed and produced according to many years of experience of producing and dealing with earth resistance and electric installation test equipment.

1.1 General description

Earth 2/3 is a professional, hand-held, battery powered test instrument. It is intended for carrying out earth resistance measurements in accordance with European standard EN 61557 - 5.

The instrument is supplied with all accessories necessary for carrying out the tests.

1.2 Warnings

In order to ensure operator's safety while carrying out various measurements and tests using the Earth 2/3, as well as to keep the test equipment undamaged, it is necessary to consider the following general warnings:

-  symbol on the instrument means »Read the Instruction manual with special care«. The symbol requires an action!
- If the test equipment is used in a manner not specified in this instruction manual, the protection provided by the equipment may be impaired!
- Do not use the instrument and accessories if any damage is noticed!
- Service intervention or adjustment and calibration procedure must only be carried out by a competent, authorized person!
- Never connect the instrument to high voltage ($U > 20 \text{ V}$).
- Turn power off and disconnect any measurement accessory connected to the instrument before opening battery cover.

1.3 Standards applied

Earth 2/3 instrument is manufactured and tested according to the following regulations, listed below:

Electromagnetic compatibility (EMC)

EN 61326	Electrical equipment for measurement, control and laboratory use – EMC requirements Class B (Hand-held equipment used in controlled EM environments)
----------	---

Safety (LVD)

EN 61010-1	Safety requirements for electrical equipment for measurement, control and laboratory use – Part 1: General requirements
------------	---

Functionality

EN 61557-1 EN 61557-5	Electrical safety in low voltage distribution systems – Part 1: General requirements Part 5: Resistance to earth
--------------------------	--

2 Instrument description

2.1 Instrument casing

The instrument is housed in a plastic enclosure, which maintains IP 40 protection class. The casing consists of a main section, which includes the operator's panel and connectors.

2.2 Front panel

The front panel consists of a custom LCD and a keyboard, see the figure below.

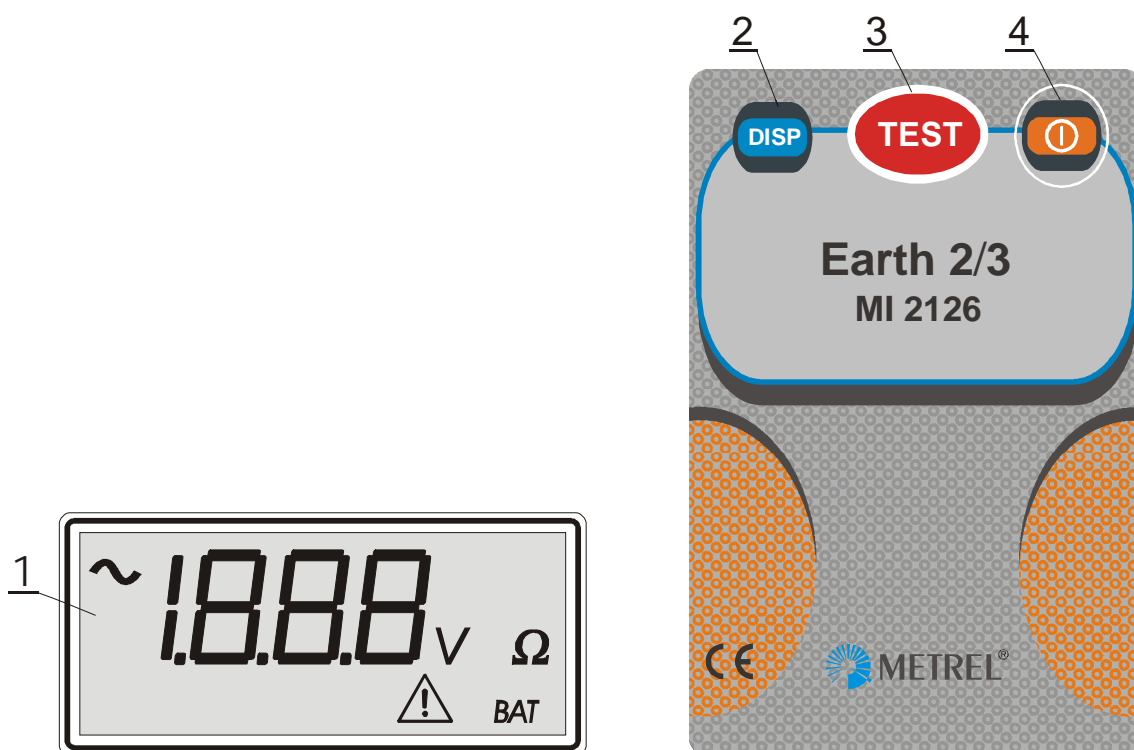

Figure 1. LCD display and front panel

Legend:

- 1 Custom LCD.
- 2 **DISP** key to display subresults.
- 3 **TEST** key to start measurement.
- 4 **ON/OFF** key to switch ON and OFF the instrument (auto OFF will occur automatically after 10 minutes of inactivity).

2.3 Connector panel

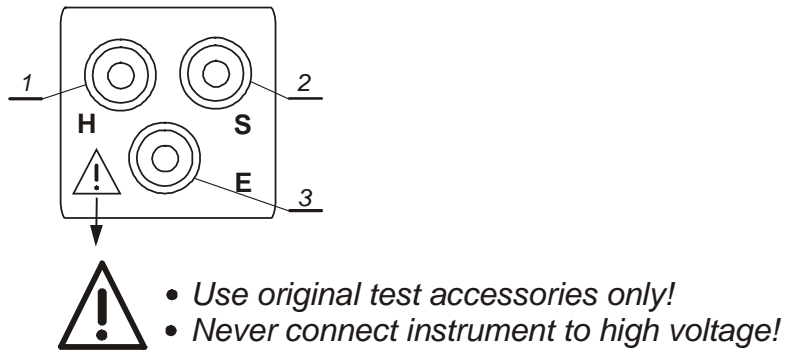

Figure 2. Connector panel

Legend:

- 1 Blue – test terminal H
- 2 Red - test terminal S
- 3 Black – test terminal E

2.4 Base

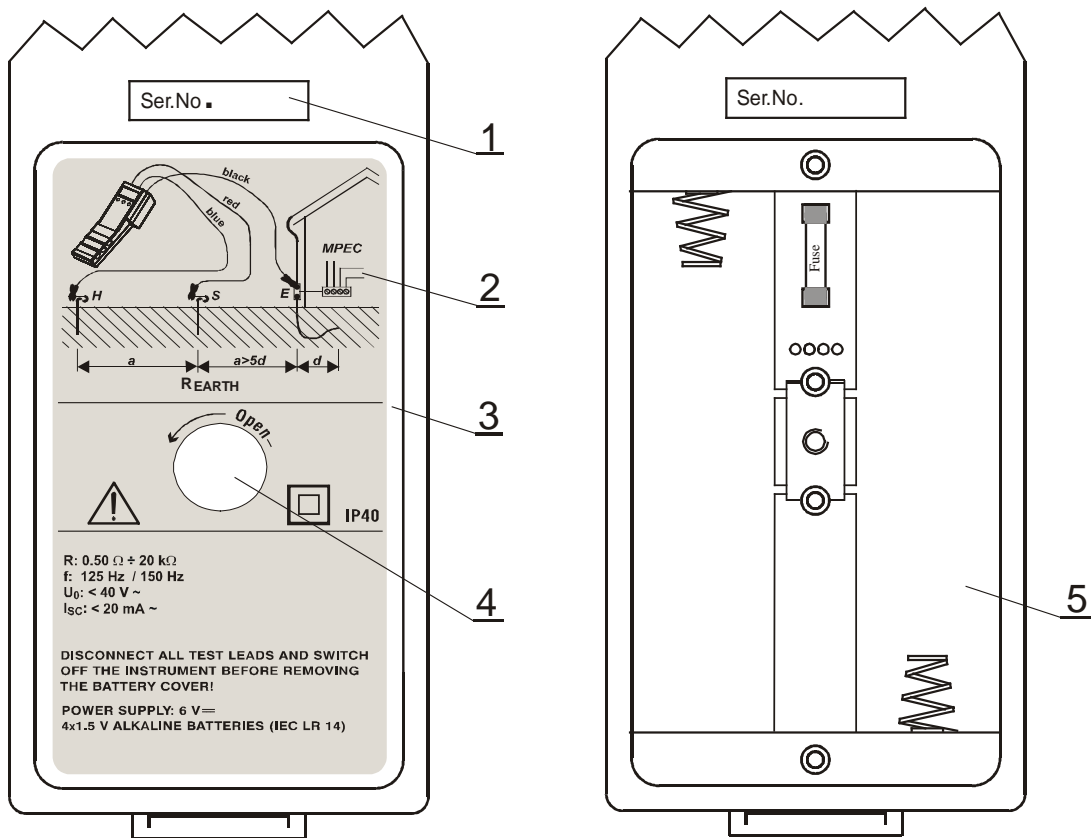

Figure 3. Base

Legend:

- 1 Serial number.
- 2 Information label.
- 3 Battery cover.
- 4 Screw to fix battery cover.
- 5 Battery holder.

2.5 Instrument messages

Messages are generated on the **LCD** using special symbols and numeric segment combinations. The following figure shows all of the possible display segments, and the table below describes the messages.

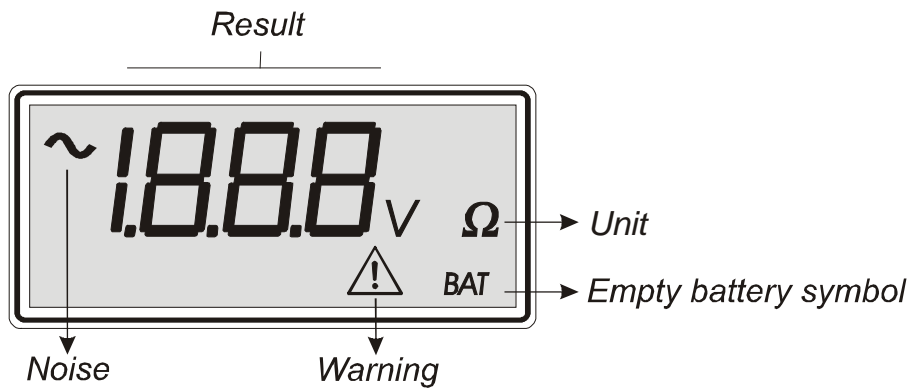

Figure 4. Display segments

Description of possible display messages:

o.r.	Result out of range.	
⚠ and 20 V	External voltage is higher than approx. 20 V _{eff} .	
⚠ (push key DISP)	⚠ and RC	Current spike resistance is too high.
	⚠ and RP	Potential spike resistance is too high.
⚠ and ~	Noise voltage is higher than approx. 3 V.	
Fr	General settings – selection of frequency (50 Hz or 60 Hz).	
t □, t □ □	General settings – selection of measuring algorithm.	
BAT	Batteries are too weak – replace the batteries.	

Table 1. Messages

Caution: if result of measurement is higher than 999 Ω, ohm character is not displayed.

3 Using instrument

3.1 Performing 3-wire measurement

The Earth 2/3 is able to carry out earth resistance measurement using three wire test method.

The distance from the earthing electrode (black, E) to the current measurement probe (blue, H) is at least 5 times the length of earthing electrode rod or the length of the band electrode (see Figure 5).

If measuring the total earth resistance of a complex earthing system, the required distance depends on the longest (diagonal) distance (d) between the individual earthing electrodes (see Figure 6).

Step 1

- Connect test leads to the instrument and to the object under test according to the figures below.

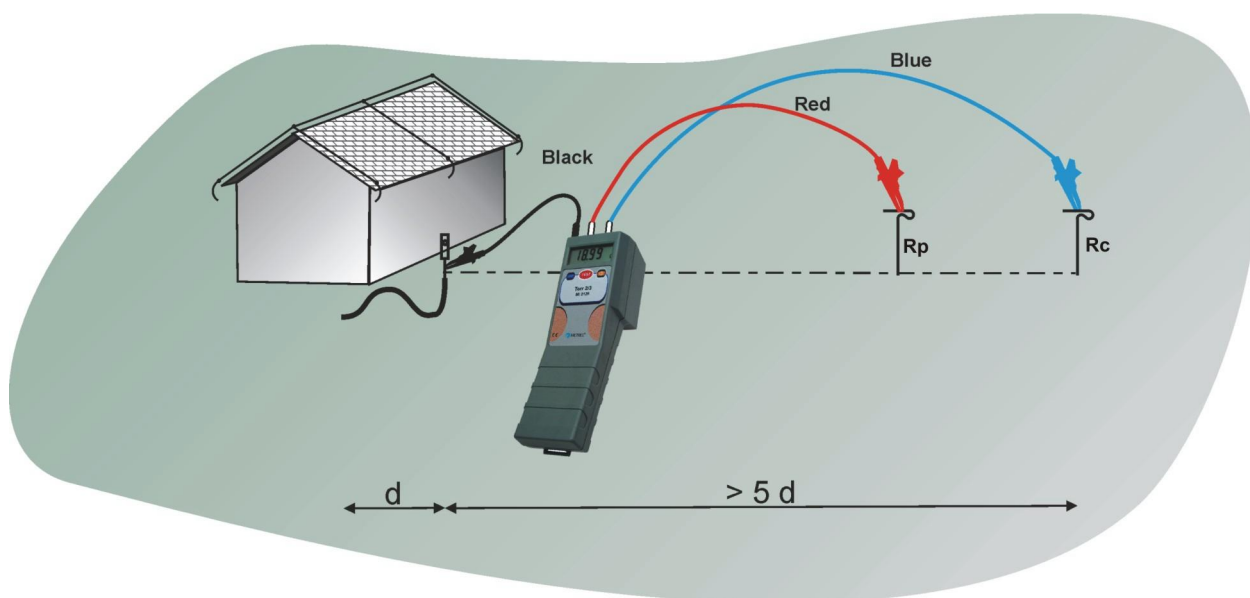

Figure 5. Connection of standard 20 m long test leads

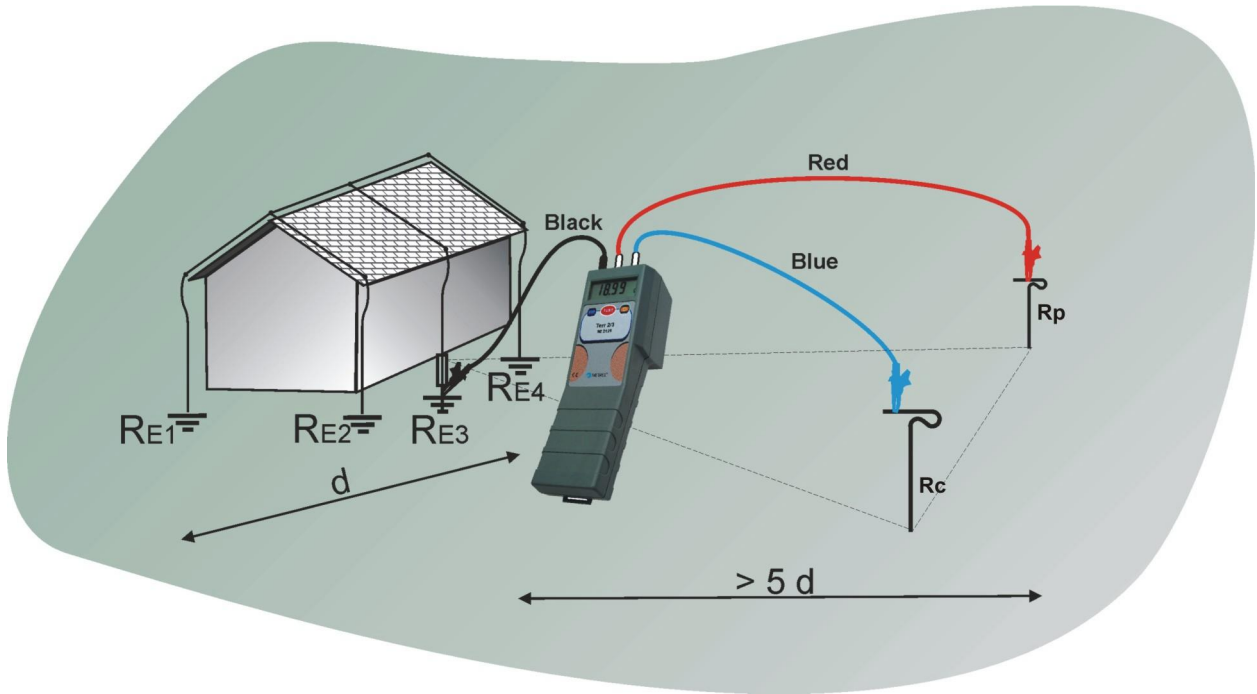

Figure 6. Connection of optional 50 m long test leads

$$R_{\text{Earthtot}} = R_{E1} \parallel R_{E2} \parallel R_{E3} \parallel R_{E4}$$

$R_{E1..E4}$Separate earthing resistances.

R_PPotential spike resistance.

R_CCurrent spike resistance.

R_{Earthtot}Total earth resistance of tested earthing system.

Step 2



Press the **ON/OFF** key, the following menu will be displayed:

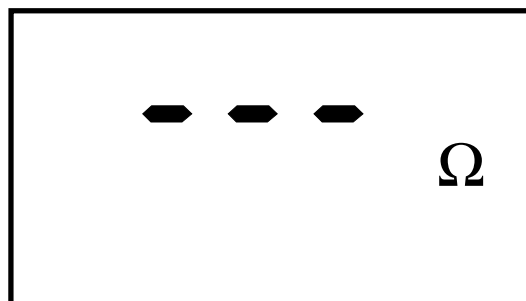

Figure 7. Earth resistance initial menu

Step 3





Press the **TEST** key and view test result. If you want to perform more than one measurement press the **TEST** key and keep it pressed until the result is stabilized, then release the key. The last result will stay displayed.



Press the **DISP** key to check the resistances of both the potential (**R_p**), and the current (**R_c**) test probes. After a short period the main result will automatically be displayed again.

Notes:

- When an external voltage higher than 20 V a.c. is present between blue (H), black (E) and red (S) test terminals, the earth resistance measurement will not be carried out after pressing the **TEST** key. The message **20 V** will be displayed instead, marked with  symbol!
- If a noise voltage higher than approx. 3 V is present between blue (H) and black (E) or red (S) test terminals, symbols \sim and  will be displayed, indicating that the test result may not be correct!
- The instrument does not indicate if a DC voltage is present at the input terminals.
- DC voltage have no influence on the measurement.
- If the resistance of the current or potential rod is too high ($>(4 \text{ k}\Omega + 100 \times R_E)$ or $>50 \text{ k}\Omega$, whichever is lower), then the result will be marked with  symbol.
- If the test result is out of measurement range **o.r.** message will be displayed.
- Measured values of R_p and R_c are in $\text{k}\Omega$.

3.2 Performing 2-wire measurement

The Earth 2/3 is able to carry out earth resistance measurement using two wire test method.

Step 1

- Connect test leads to the instrument (red (S) and blue (H) together) and to the object under test according to the figures below.

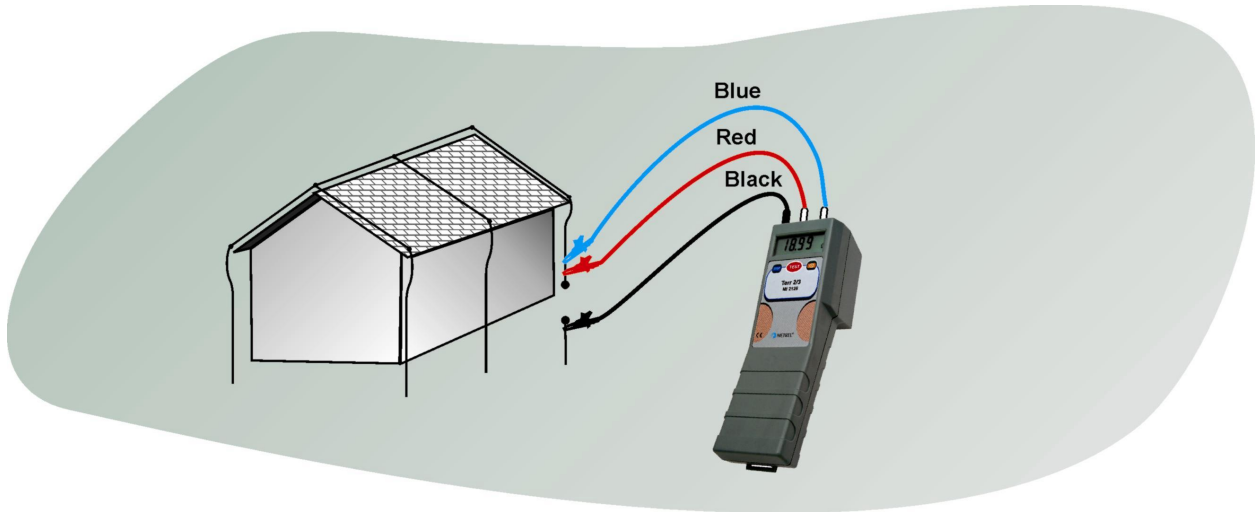

Figure 8. Two-wire test method – dependent objects.

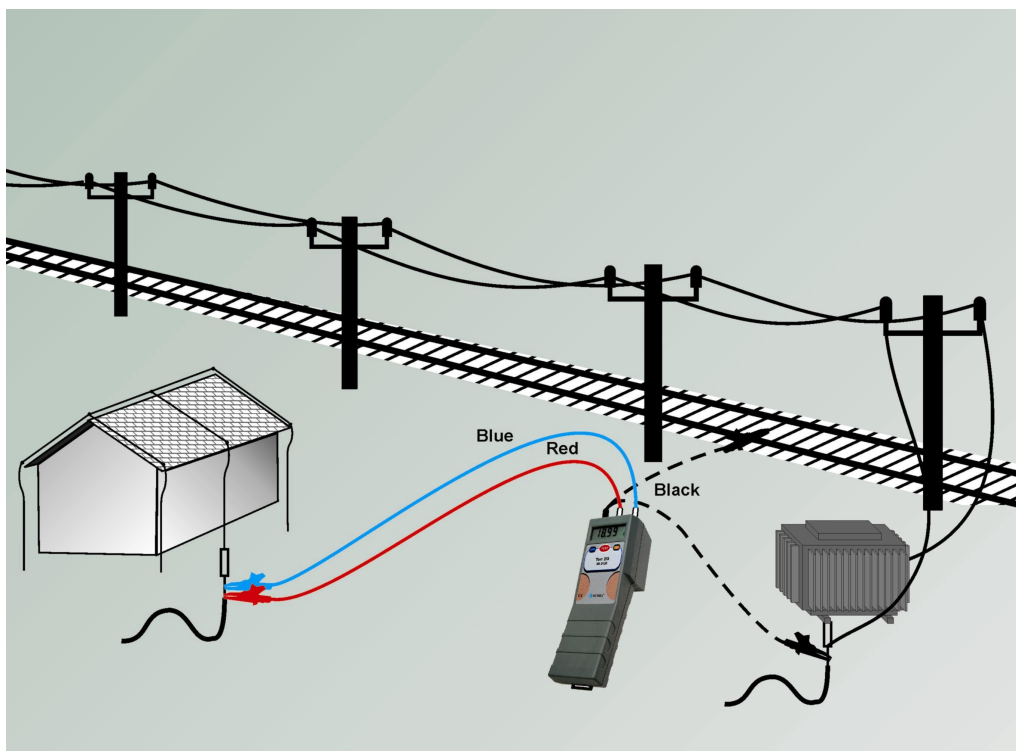

Figure 9. Two-wire test method - independent objects.

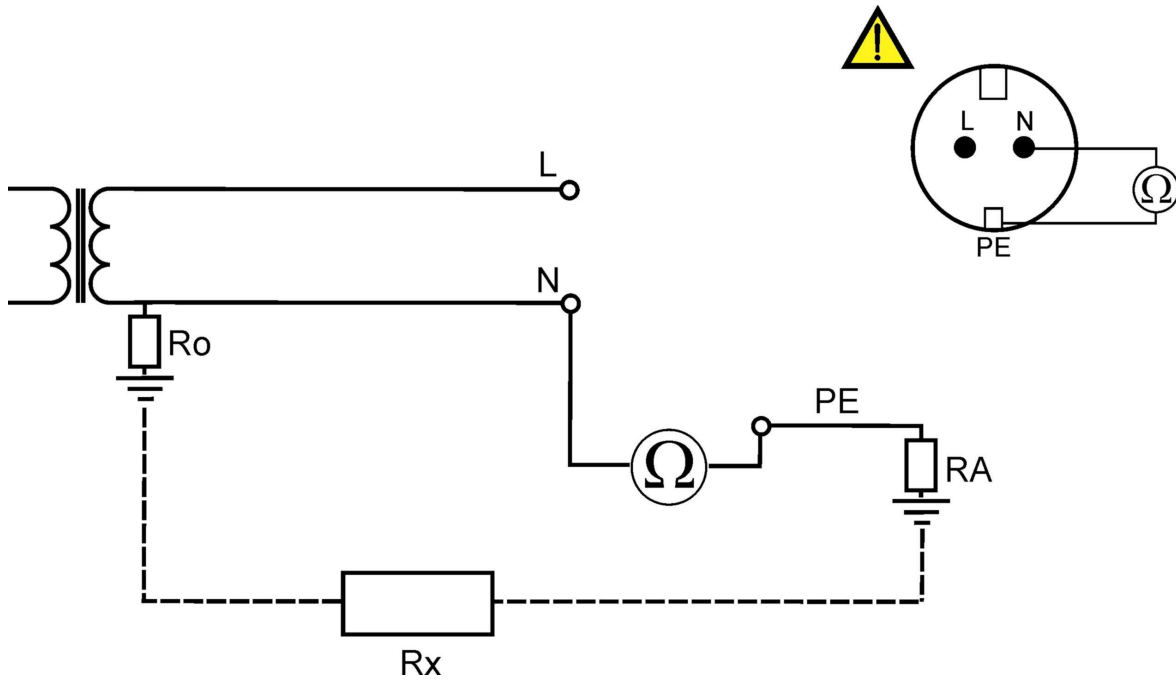

Figure 10. Two-wire test method – TT network system method

Warning:

-  Make sure that test leads are not connected to the phase line.

$$R_{\text{Earthtot}} = R_A + R_O + R_X$$

R_X Earth resistance.

R_A Resistance of protective conductor.

R_O Resistance of earthing electrode.

R_{Earthtot} Total earth resistance of tested earthing system.

Step 2



Press the **ON/OFF** key, the following menu will be displayed:

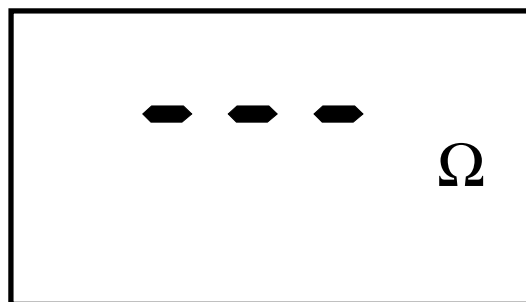

Figure 11. Earth resistance initial menu

Step 3





Press the **TEST** key and view test result. If you want to perform more than one measurement press the **TEST** key and keep it pressed until the result is stabilized, then release the key. The last result will stay displayed.



Press the **DISP** key to check the resistances of both the potential (**R_p**), and the current (**R_c**) test probes. After a short period the main result will automatically be displayed again.

Notes:

- When an external voltage higher than 20 V a.c. is present between blue (H), black (E) and red (S) test terminals, the earth resistance measurement will not be carried out after pressing the TEST key. The message 20 V will be displayed instead, marked with  symbol!
- If a noise voltage higher than approx. 5 V is present between the blue (H) and black (E) or red (S) test terminals, symbols ~ and  will be displayed, indicating that the test result may not be correct!
- The instrument does not indicate if a DC voltage is present at the input terminals.
- DC voltage have no influence on the measurement.
- If the resistance of the current or potential rod is too high ($>(4 \text{ kW} + 100 \times R_E)$ or $>50 \text{ kW}$, whichever is lower), then the result will be marked with  symbol.
- If the test result is out of measurement range o.r. message will be displayed.

3.3 General settings

There is usually voltage or current noise present on the earthing system under test, caused by mains voltage somewhere in the near or far vicinity. Mains voltage frequency is different between countries (e.g. 50 Hz in the European countries, 60 Hz in the United States). In order to get stable test results, regardless of noise levels, it is advisable to set the nominal frequency of the mains system.

The instrument measuring system assures excellent noise immunity. In extremely noisy conditions, the stability of results can be further improved by means of averaging.

The frequency and algorithm, once set, will be effective even after replacing batteries.

Setting the frequency of mains voltage (50 Hz/60 Hz) and measuring algorithm

Keep the **TEST** key pressed while switching on the instrument until **Fr** followed by **50** or **60** value (last selected) starts to flash.

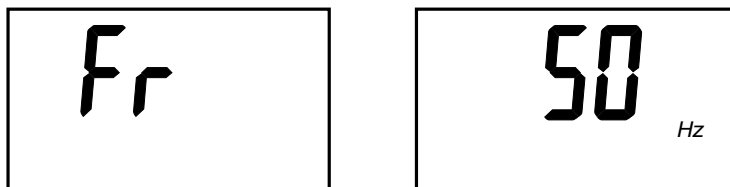

Figure 12. Selecting frequency



Select frequency of mains voltage.



Confirmation of mains frequency selection. Measuring algorithm type starts to flash.

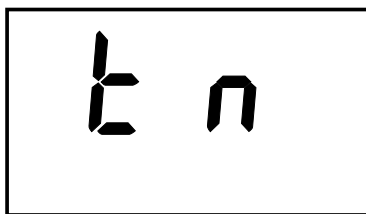

Normal algorithm (fast)

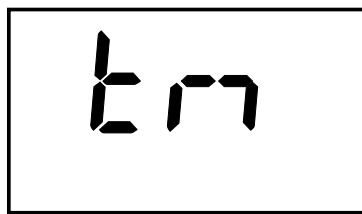

Improved noise rejection algorithm (by means of averaging techniques)

Figure 13. Selecting algorithm



Select measurement algorithm.



Confirmation of measuring algorithm. The instrument is ready for measurements.

Notes:

- In general it is recommended to use normal measuring algorithm because of the instrument high intrinsic noise immunity.
- If the results are unstable improvements can be achieved by averaging, ie. selecting the improved measuring algorithm. However, this prolongs the measuring time significantly (up to 20 s).
- New selection of parameters is also offered after each reset of the instrument.
- If DISP key is pressed when switching on the instrument, the instrument will stop responding (this function is used for special purposes). If this happens remove and reinsert the batteries.

4 Maintenance

4.1 Batteries

The battery symbol - BAT in the lower right corner of the LCD indicates a low battery state. If a low battery state is indicated, the batteries must be replaced to ensure accurate measurements.

Observe the battery condition even when carrying out measurements. Results obtained with low battery voltage will be marked with BAT after finishing the measurement (the results may be incorrect).

The instrument is switched off automatically when battery voltage drops below the limit, BAT is displayed for a few seconds before switching off.

Nominal power supply voltage is 6 V d.c.. Use four 1.5 V alkaline batteries, type IEC LR14 (dimensions: diameter = 26 mm, height = 50 mm).

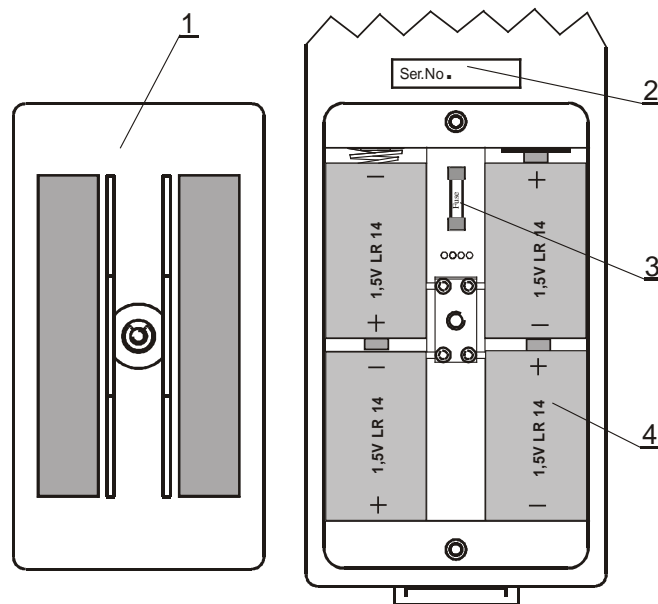



Figure 14. Correct polarity of inserted batteries

Legend:

- 1 Battery cover.
- 2 Serial number.
- 3 Fuse.
- 4 Battery cells.

One set of full-capacity alkaline batteries can supply the instrument for approx. 50 hours. Rechargeable NiCd or NiMH battery can be used instead of alkaline.

Notes:

- Replace all four batteries at the same time! Batteries must be of the same type.
-  Turn power off and disconnect any measurement accessory connected to the instrument before opening battery cover.
- Insert the cells correctly, otherwise test instrument will not operate and batteries may be discharged. See figure 14 for correct battery polarity.
- If the instrument is not used for a long period of time remove all cells from the battery compartment.

4.2 Replacing fuse

The instrument contains a fuse to protect the instrument from damage if the batteries are incorrectly inserted. See figure 14 for fuse location.

Warning!

-  Turn power off and disconnect any measurement accessory connected to the instrument before opening battery cover.
- Replace blown fuse with original type only (M0.8A), otherwise the instrument may be damaged or operator's safety impaired.

4.3 Cleaning

Use soft cloth slightly moistened with soapy water or alcohol to clean the surface of the instrument and leave it to dry totally before use.

Notes:

- Do not use liquids based on petrol or hydrocarbons!
- Do not spill cleaning liquid over the instrument!

4.4 Periodic calibration

Technical specification is warranted only if the instrument is calibrated at least once per year by a competent service department. Contact your dealer for detailed information

4.5 Service

For repairs under warranty, or at any other time, please contact your distributor.

5 Technical specification

5.1 Functions

Earth resistance, two-wire method, three-wire method

Measuring range according to EN61557-5 is: 1.77 Ω ÷ 19.99 k Ω .

Display range (W)	Resolution (W)	Accuracy
0.00 ÷ 19.99	0.01	±(2 % of reading + 10 digits)
20.0 ÷ 199.9	0.1	
200 ÷ 999	1	
1.000 k ÷ 1.999 k	1	
2.00 k ÷ 19.99 k	10	±(5 % of reading)

Auxiliary earth electrode resistance R_C	100 $\times R_E$ or 50 k Ω (whichever is lower), indicator only
Probe resistance R_P	100 $\times R_E$ or 50 k Ω (whichever is lower), indicator only
Additional probe resistance error at R_{Cmax} or R_{Pmax} .	±(10 % of m. r.* + 3 digits)
Additional error at 3 V voltage noise (50 Hz / 60 Hz)	±(5 % of reading + 10 digits)
Automatic noise voltage indication threshold	3 V (<50 Ω , worst case)
Open-terminal test voltage	< 40 V a.c.
Test voltage shape	sine wave
Test voltage frequency	125 Hz / 150 Hz
Short-circuit test current	< 20 mA
Automatic test of curr. and pot. test probe resistance	yes
Automatic test of voltage noise	yes

Accuracies apply for 1 year in reference conditions. The error in operating conditions could be at most the error for reference conditions (specified above) +1 % of reading + 2 digits.

*m.r. measuring range

5.2 General characteristics

Power supply	6 V _{DC} (4 × 1.5 V battery IEC LR14) or 4.8 V _{DC} (4 × 1.2 V NiCd, NiMH)
Auto power off	yes, approximately 10 min without activity
Visual warnings	yes
Dimensions (w × h × d)	280 x 70 x 80 mm
Weight (without accessories and batteries)	410 g
Display	custom LCD
Protection classification	double insulation
Degree of protection	IP 40
Working temperature range	0 °C ÷ 40 °C
Nominal (reference) temp. range	0 °C ÷ 35 °C
Max. humidity	85 % RH (0 °C ÷ 40 °C)
Nominal (reference) humidity range	40 % RH ÷ 70 % RH

6 Standard and optional accessories

See attached sheet to compare received set of accessories with listed one. The optional accessories may be supplied upon request.